

SMART SCOPE TONE

12V

NL | Raadpleeg de handleiding van de transformator en kabel voorafgaand aan de installatie van dit armatuur | Gebruik dit product alleen binnen het in-lite systeem. Wanneer in het systeem componenten worden gebruikt die niet van in-lite afkomstig zijn, vervalt het recht op garantie | Monteer de componenten van het in-lite systeem (armaturen, transformators, mini-connectors, Easy-Locks en kabelverbinders) zodanig dat zij altijd vervangen kunnen worden | Gebruik de in-lite laagspanningskabel nooit in combinatie met 100-240V. Deze is alleen geschikt voor het gebruik in combinatie met de onderdelen van het in-lite 12 volt laagspanningssysteem.

EN | Read through the manual for the transformer and cable before installing this fixture | This product may only be used within the in-lite system. If components are used in the system that do not originate from in-lite, the warranty no longer applies | Install the in-lite system components (fixtures, transformers, mini-connectors, Easy-Locks and cable connectors) so that they can easily be replaced | Never use the in-lite low-voltage cable in combination with 100-240V. This is only suitable for use with the components of the in-lite 12 volt low-voltage system.

DE | Beachten Sie die Bedienungsanleitung für den Transformator und das Kabel, bevor Sie mit der Montage dieser Lampe beginnen. | Verwenden Sie dieses Produkt nur in einem in-lite-System. Wenn im System Komponenten verwendet werden, die nicht von in-lite stammen, verfällt der Garantieanspruch | Montieren Sie die Komponenten des in-lite-Systems so (Lampen, Transformatoren, Mini-Verbinder, Easy-Locks und Kabelverbinder) so, dass sie jederzeit ersetzt werden können | Verwenden Sie das in-lite Niederspannungskabel nicht in Kombination mit 100-240V. Es ist nur für die Verwendung in Kombination mit Teilen des in-lite 12-Volt-Niederspannungssystems geeignet.

NO | Se bruksanvisningen for transformatoren og kabelen før denne lampen installeres | Dette produktet må bare brukes i forbindelse med in-lite systemet. Hvis det benyttes komponenter i systemet som ikke kommer fra in-lite, forfaller retten til garanti | Monter komponentene i in-lite systemet (lamper, transformatorer, minikontakter, Easy-Lock og kabelskjøtere) slik at de alltid kan skiftes | Lavspenningskabelen fra in-lite må aldri brukes til 100-240 V. Den er kun egnet til bruk sammen med delene fra in-lite 12 volt lavspenningssystem.

SE | Läs bruksanvisningen till transformatorn och kabeln innan du installerar armaturen | Använd bara denna produkt i kombination med in-lite-systemet | Om komponenter används i systemet som inte kommer från in-lite, förfaller garantin | Montera alltid komponenterna i in-lite-systemet (armaturer, transformatorer, mini-connectors, Easy-Locks och kabelkopplingar) så att man lätt kan komma åt dem | Använd aldrig lågspänningskabeln i kombination med 100-240 V | Den är endast lämplig för användning i kombination med ett lågspänningssystem på 12 V.

FR | Consultez le manuel du transformateur et du câble préalablement à l'installation de cette armature | Utilisez ce produit uniquement au sein du système in-lite. Lorsque des composants non d'origine in-lite sont utilisés dans le système, tout droit à garantie devient caduc | Montez les composants du système in-lite (armatures, transformateurs, mini-connecteurs, systèmes Easy-Lock et raccords de câble) de manière à ce qu'ils puissent toujours être remplacés | N'utilisez jamais le câble basse tension in-lite en combinaison avec le 100-240 V. Celui-ci convient uniquement pour l'utilisation en combinaison avec les composants du système basse tension 12 volts in-lite.

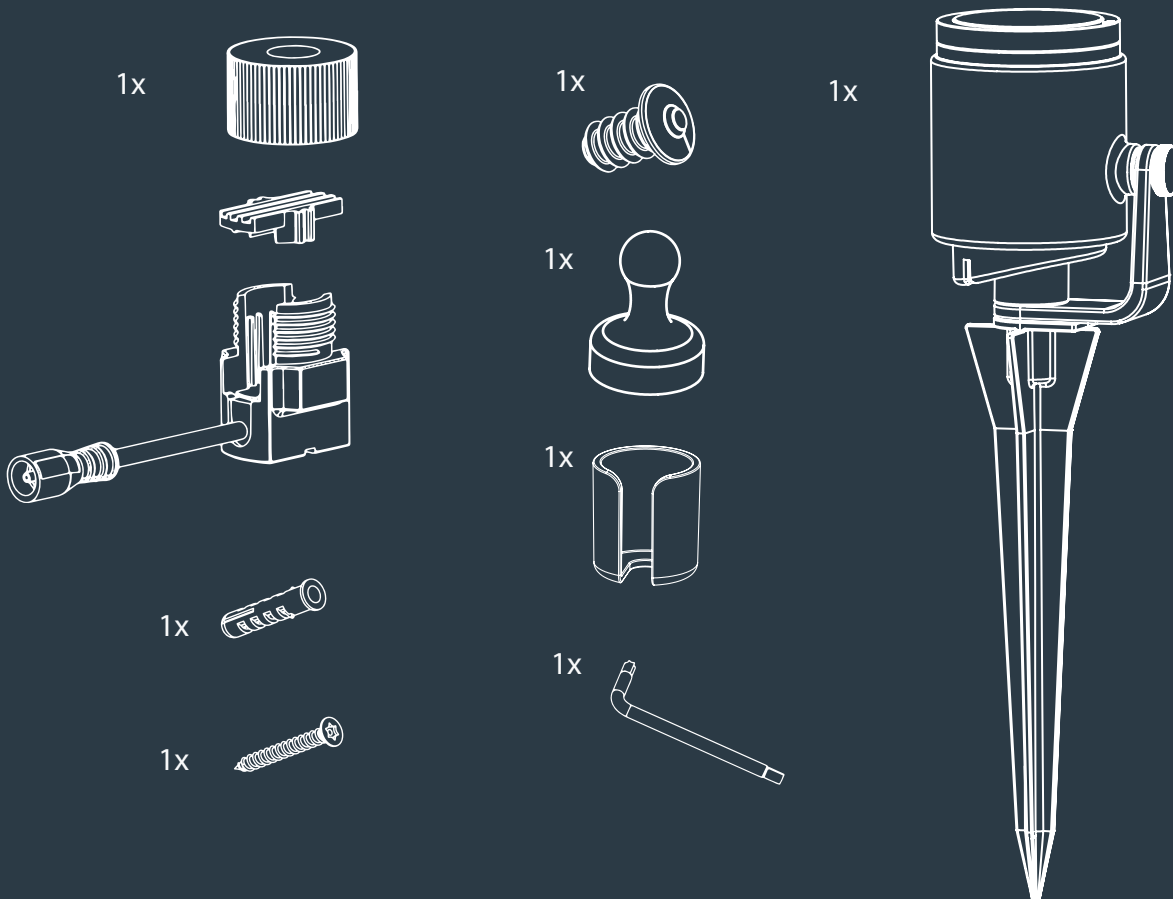

option 1 soil/gravel

1



2

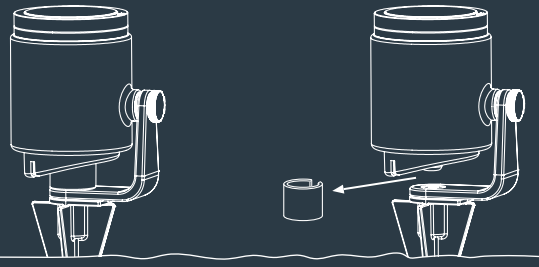

3

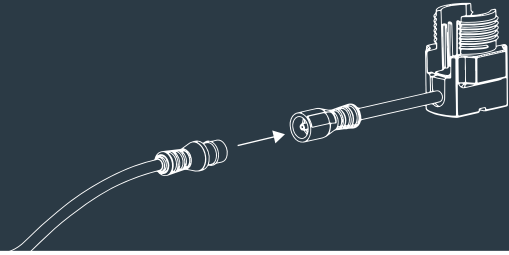

4

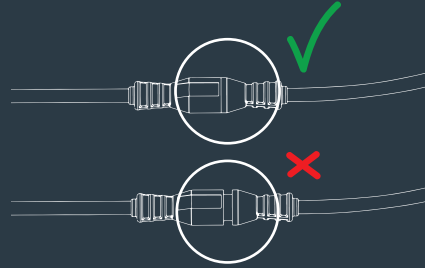

5

in-lite 12volt cable



6

Transformer "ON"

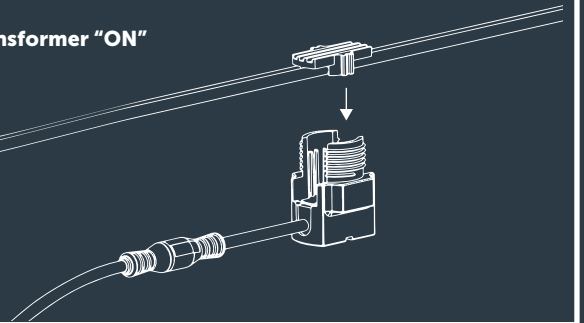

7

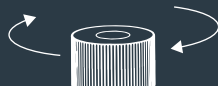

8

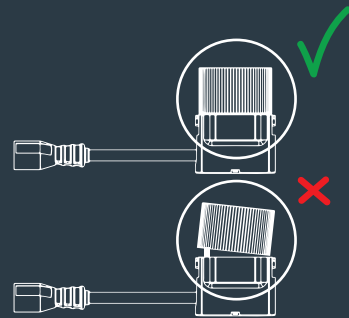

9

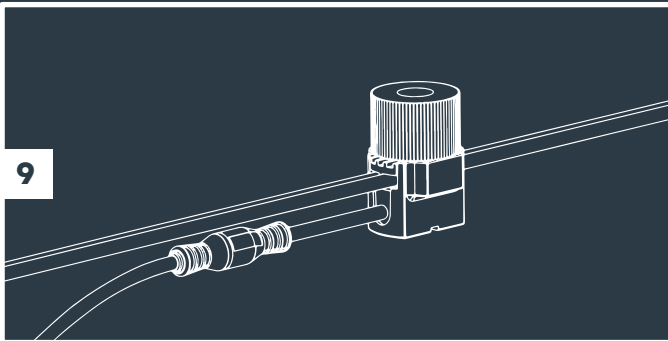

10

Continue with app instalation
(step ..x..)



in-lite

option 2 stone/wood

11

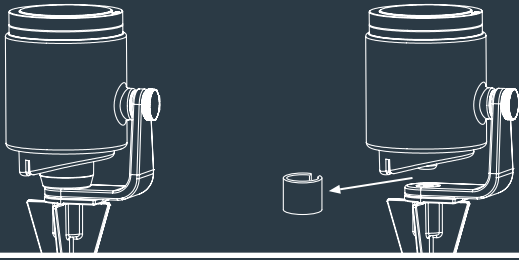

12

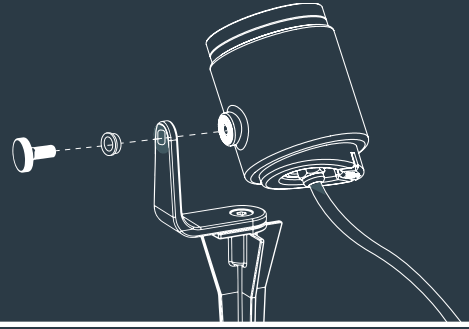

13

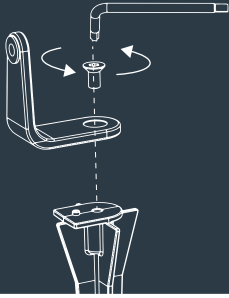

14

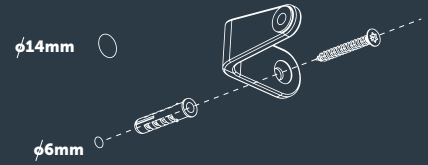

15

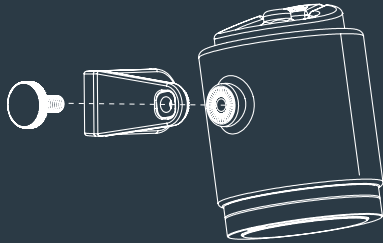

16

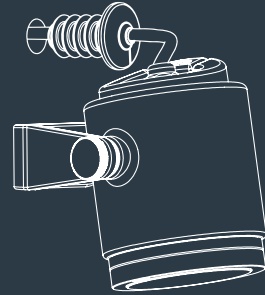

17

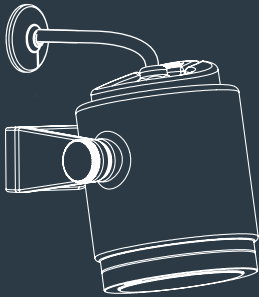

18

Continue with EASY-LOCK
installation (step 3 - 9)

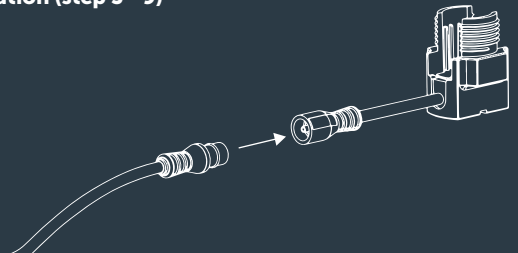

19

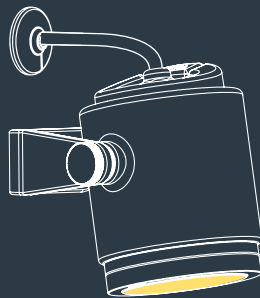

Open the in-lite app
Go to Settings -->
Garden -->
Smart lights

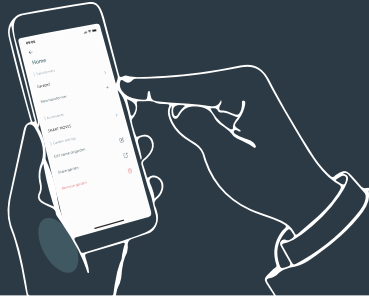

Finish installation
in the in-lite app

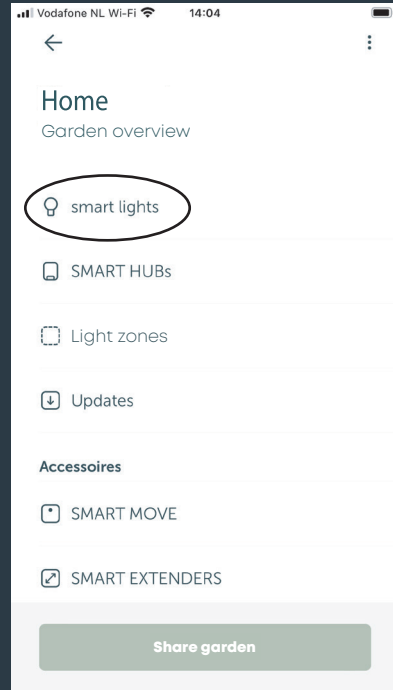

OPTIONAL
Reset SCOPE TONE

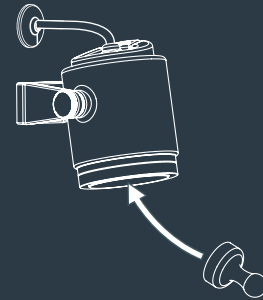

1. Light flashes blue 1x
2. Hold the magnet in position
3. Light flashes blue repeatedly

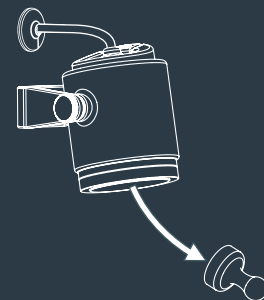
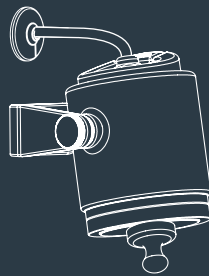

in-lite